

thermo scientific

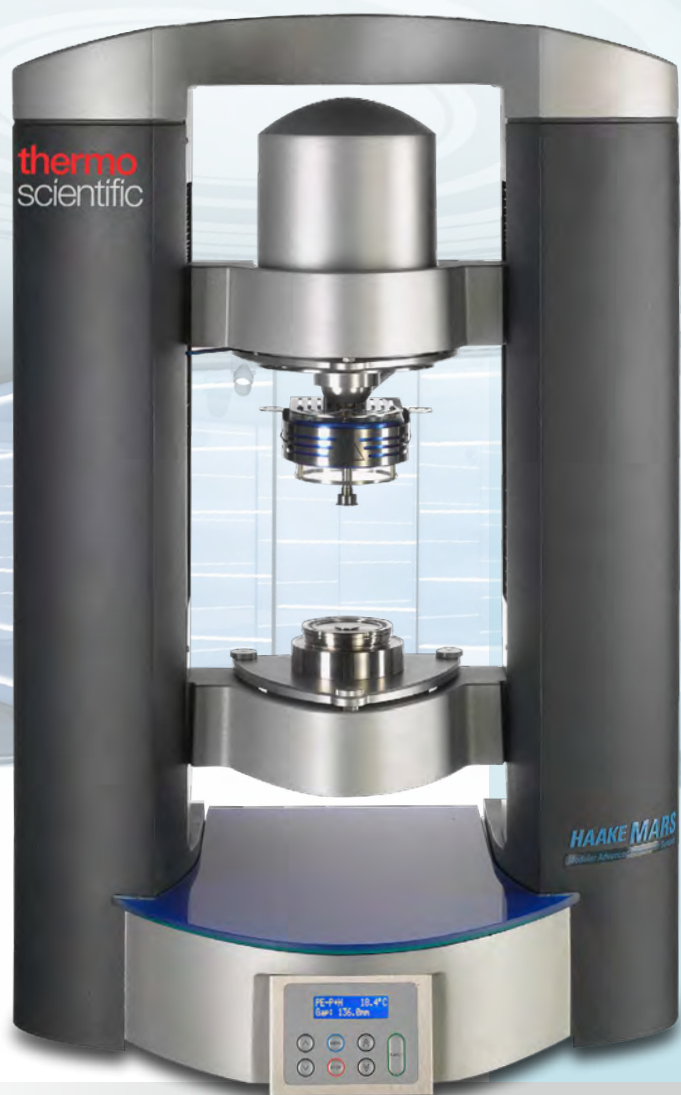

Thermo Scientific HAAKE MARS 40/60 Rheometers

Modular Rheometer Platform
Discover the MARS Factor

MARS factor 01

Future-orientation

What we offer most likely exceeds your present requirements, but will support your future applications without exception.

As a world leader in serving science, we bring highperformance rheometers to scientists in advanced quality control and applied research.

In developing our Modular Advanced Rheometer System (MARS), we focused the Thermo Scientific™ HAAKE™ MARS™ Rheometer Platform on the following factors:

- Future-orientation
- Accuracy
- Ease of use
- Modularity
- Application-based solutions

Bring the flexibility of the HAAKE MARS platform to your lab and see how quickly you can respond to changing testing requirements of today's new materials. The enhanced modularity expands your options to analyze the most demanding challenges faced by the pharmaceutical, petrochemical, mining, cosmetics, food, coatings and paints, and polymer industries.

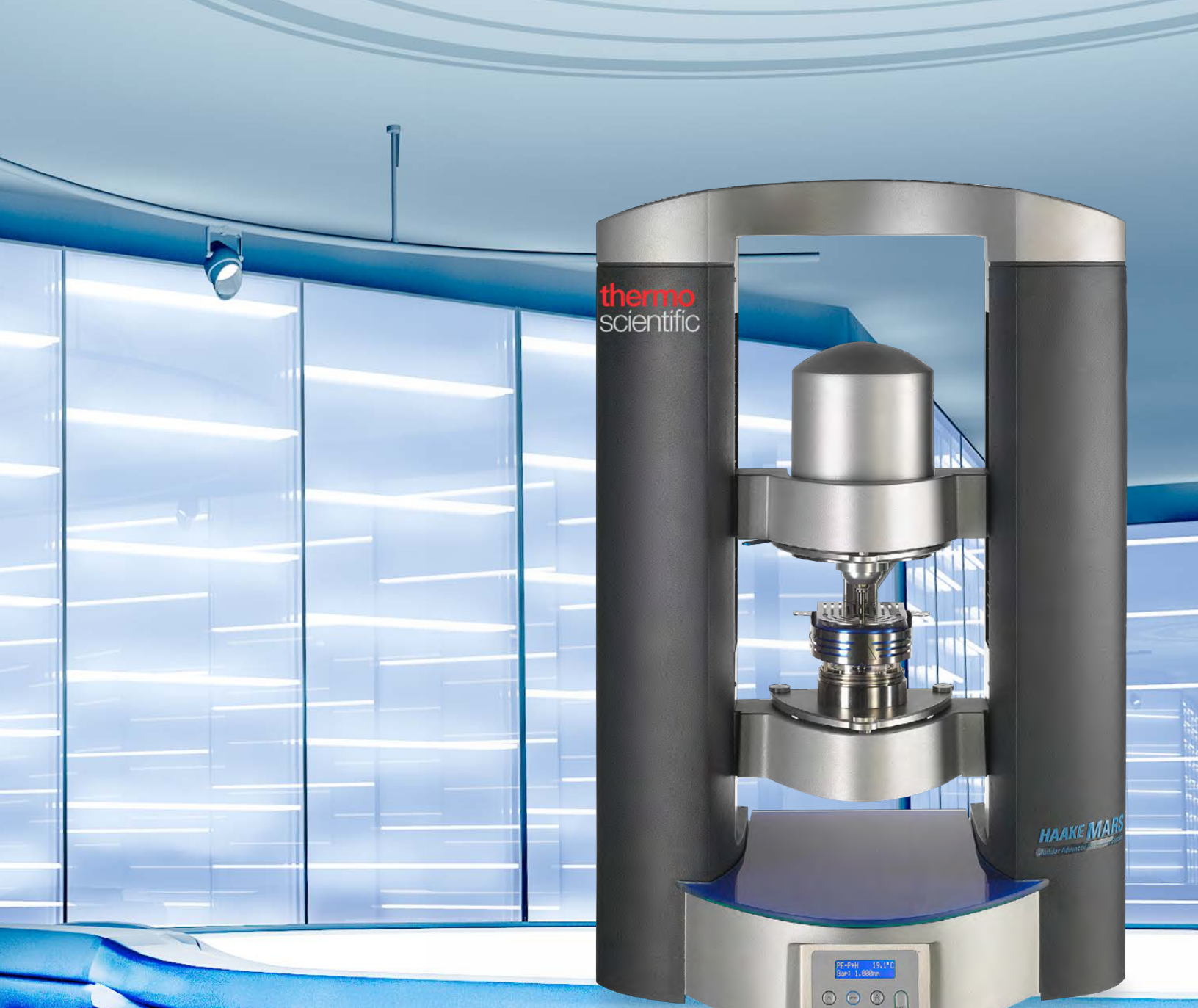

Expandable for the Future

HAAKE MARS – rheometer platform

in different models for individual demands – today and tomorrow:

- Wide range of accessories
 - Temperature modules
 - Application-focused measuring cells
 - Measuring geometries
- Adaptable to evolving testing requirements with new accessories
- Hardware and software upgrades for existing HAAKE MARS users to easily incorporate future technological innovations
- Compatible with the Thermo Scientific™ HAAKE™ Viscotester™ iQ Rheometer and Thermo Scientific™ HAAKE™ MARS™ iQ Rheometer Series for transferring test methods from research and development to quality control.

MARS factor 02

Accuracy

Mounting rods (optional) for the temperature-controlled test chamber and additional modules for combined measurement methods

Measuring head with mount for upper temperature module lifts to accommodate sample

Fixer lower mount for temperature modules and other application-orientated modules (Thermo Scientific™ HAAKE™ RheoScope™, Rheonaut)

Ergonomic 7 button control panel for status/error display, lift control and rotor release

Additional access from below for individual testing requirements

Integrated control electronics for exchangeable temperature modules including control valves for optimal temperature control

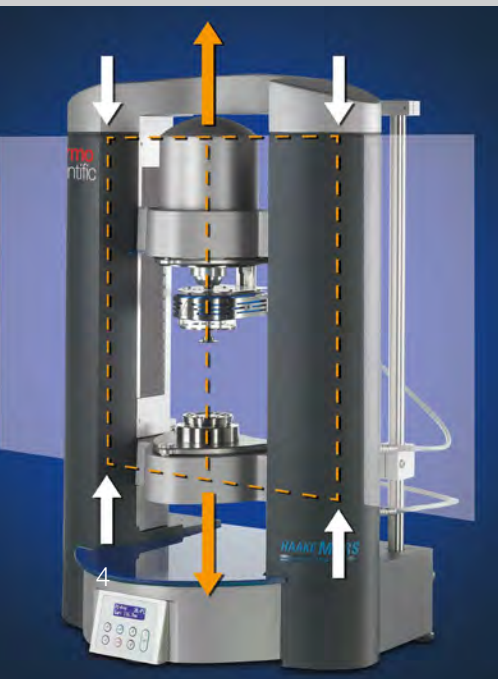
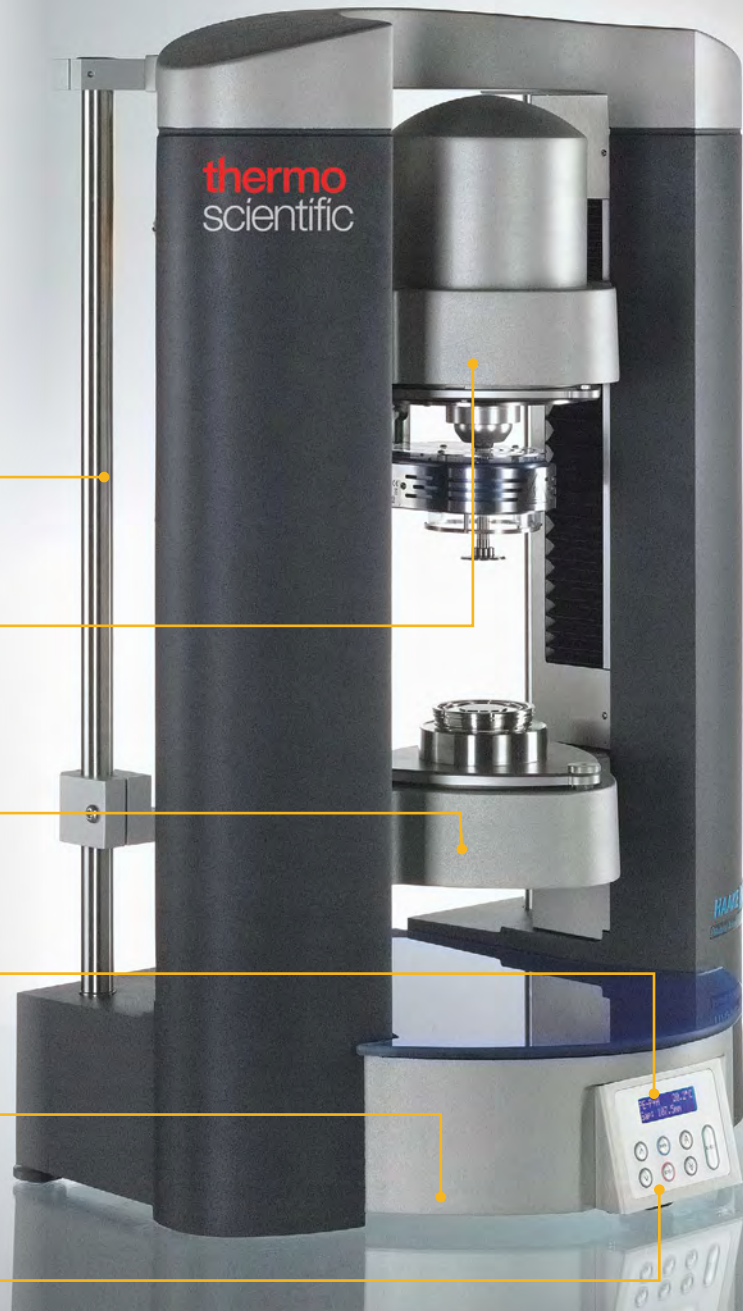

H-shaped frame for optimal force distribution

A one-piece, aluminum-cast H-shaped frame offers unmatched stability and force distribution for reproducible results.

The active forces from the sample and the reactive forces in the frame work in the same plane in the HAAKE MARS “H-shaped” frame. This effectively prevents the measuring gap from widening as a result of high normal forces compared to a standard “C-shaped” frame.

HAAKE MARS measuring head with optimized, unique components

Fourth generation unique diffusion air bearing with extremely low moment of inertia to measure at very low torques

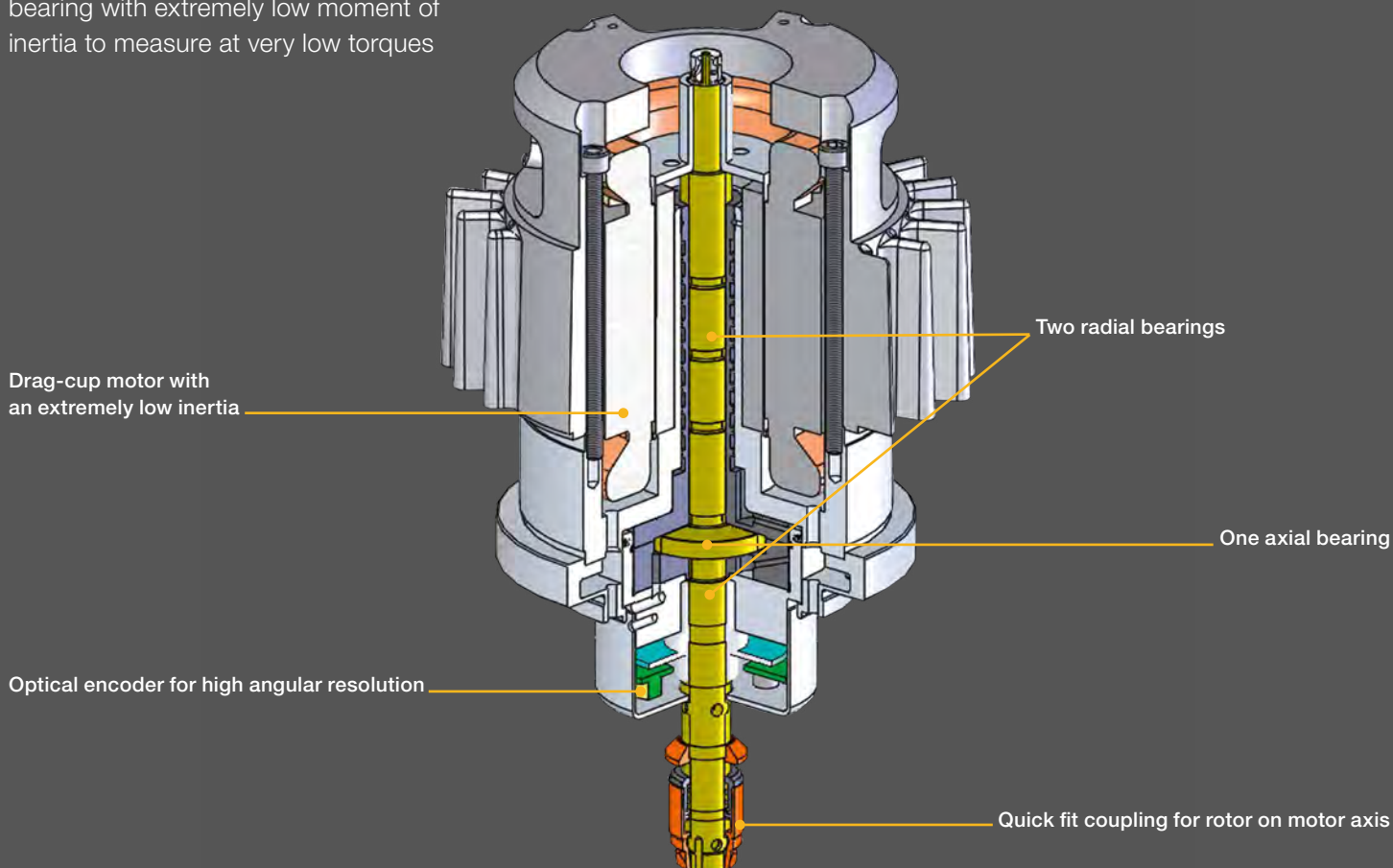

Motor

The HAAKE MARS drag cup motor features the lowest inertia of 10^{-5} kgm^2 and due to that has fast response characteristics. The integrated memory chip contains all relevant calibration data and therefore allows a quick exchange of the measuring head without time-consuming calibration.

Optical encoder

The HAAKE MARS optical encoder is mounted to the bottom of the measuring head to minimize the influence of the inevitable compliance of the motor shaft. The optical encoder has a very high resolution of 12 nanorad, enabling for instance the determination of the zero-shear viscosity at ultra low shear rates $< 10^{-6} \text{ s}^{-1}$ or probing delicate samples in oscillation at very small deformations.

Air bearing

The highly precise and unique fourth generation air bearing in the HAAKE MARS is the result of more than 30 years of experience and development.

The HAAKE MARS air bearing system is based on the interaction of three individual air bearings:

- One axial air bearing, supporting the motor shaft in the vertical direction, and is responsible for excellent axial stiffness.
- Two separate, widely spaced radial air bearings support the motor shaft in the radial direction.

Normal force sensor

The unique normal force sensor is based on temperature-compensated strain-gauge technology and offers high-resolution normal force measurements within a range of 0.01 N to 50 N in both the positive and negative direction. Sensitive tensile strain measurements become possible.

Furthermore, it's feasible to perform quick normal force measurements, as well as a timely and accurate compensation of positive and negative normal forces that may result from shrinkage or expansion of the sample.

MARS factor 03

Ease of use

User-focused design minimizes errors and simplifies operation

Pneumatic rotor release for a convenient handling

Remove the rotor with the click of a button or simple release of the rotor after curing or crosslinking reactions as part of an automated job routine.

TCP/IP ethernet interface for fast data acquisition

Using the TCP/IP Ethernet data communication interface allows data points to be acquired and displayed every two milliseconds in real time, critical when measuring samples with fast changing properties, e.g., UV-curing materials.

Integrated web server for password-protected remote control and maintenance

The rheometer has its own IP address, so the integrated web server can be accessed via the internet or company intranet for remote operation or to monitor measurements as they happen.

"Connect Assist" technology for a fast accessory exchange

Temperature modules and measuring geometries with quick couplings are automatically recognized by the HAAKE MARS to reduce mistakes and assure perfect alignment.

Optimized measuring geometries for accurate sample loading

Lower measuring plates with the same diameter as the upper plate or cone geometry assures correct sample filling.



Universal temperature module for maximum measuring flexibility

Switching between coaxial cylinder geometries, plates and cones occurs in seconds by using a measuring plate insert.



MARS factor 03

Ease of use

Customizable HAAKE RheoWin Software

Components

- Thermo Scientific™ HAAKE™ RheoWin™ JobManager for fully automated process control of measuring Jobs and analysis routines and report printout or export
- RheoWin DataManager for interactive evaluation of measured data as well as sophisticated tools for creating reports and generating templates for graphs, tables and screen views
- RheoWin UserManager for comprehensive user management regarding user access control and assignment of specific access rights

Customization

- User-defined configuration of paths and subdirectories for data filing
- Push-button selection of one out of 12 languages
- Automatic and modular generation of a file name and automated saving in a predefined subdirectory
- Data transfer to ERP and laboratory systems (e.g. SAP®, LIMS, etc.)
- Snapshot for quick characterization of an unknown sample
- RheoWizard expert help to set up a measuring routine
- Customizable report templates to permit the use of custom logos and text

Functionality

- Monitor mode for preliminary testing, for displaying selected parameters and for saving manually acquired data
- Convenient creation and customization of measuring routines using predefined measuring and evaluation elements via “drag and drop” techniques
- Fully automated measurement, analysis and documentation within one measuring procedure
- Real multitasking – simultaneous measurements using several rheometers and data evaluation
- Freely configurable data export (ASCII, MS-Excel®, XML)
- Save graphs in a wide variety of formats (pdf, jpg, etc.)
- Numerous algorithms for data analysis (e.g. interpolation, regression and automated quality control)
- Availability of saving the raw data and numerical values for data evaluation
- Loop programming with break criteria
- Integrated image capture with USB and Firewire camera
- Save numerical raw data of oscillation (OSC) and rotational (ROT) measurements for further evaluation

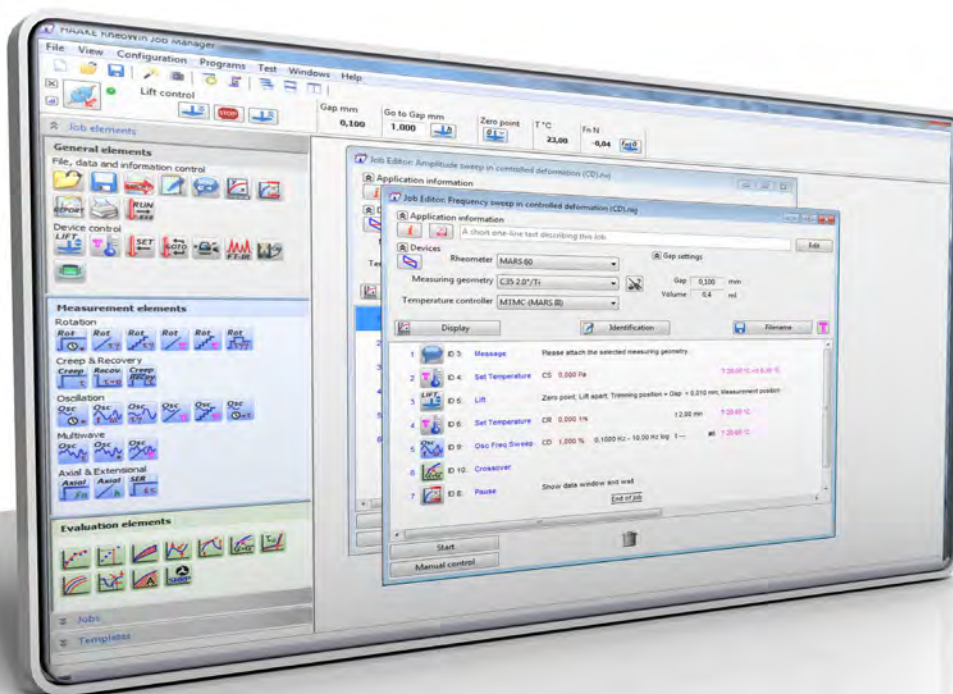

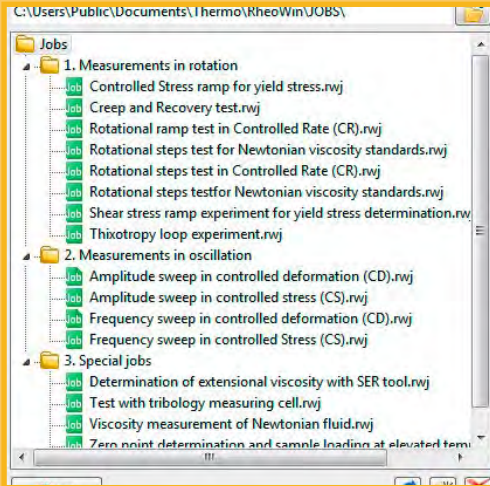

Predefined methods (Jobs) with explanation and user guidance

All predefined measuring Jobs include comprehensive test explanations and further application related information (e.g., application reports)

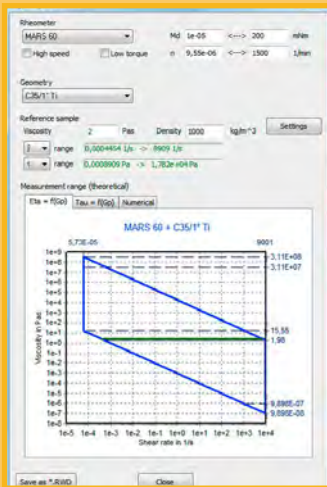
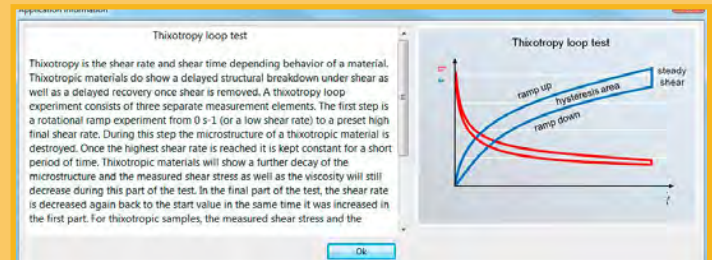

RheoWin range calculator

- Displays the maximum and the optimal measuring range for all available measuring geometries
- Measuring range plot can be overlaid with actual measurement plot to assess data quality
- Shows the occurrence of Taylor vortices for coaxial cylinder measuring geometries

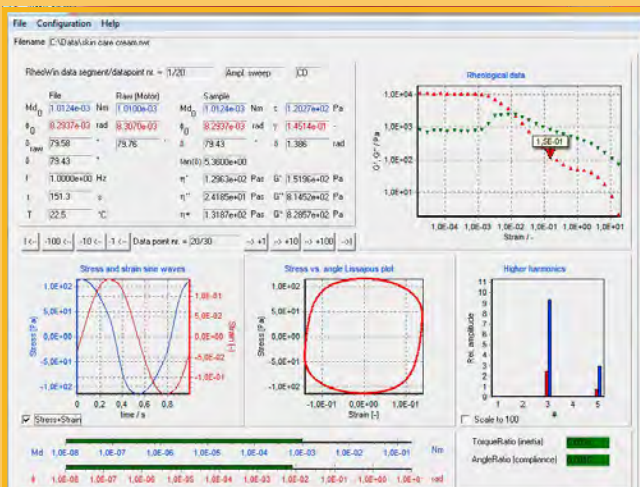

RheoWin raw data viewer

The RheoWin raw data v-iewer provides the following information:

- Sine wave raw data for stress and strain
- Lissajous plots for further data analysis
- Contributions of third and fifth higher harmonics to stress and strain sine wave
- Influence of instrument inertia and rotor compliance on test results
- Raw data for rotational step experiments

MARS factor 04

Modularity

Measure from water-like samples up to solids using individual measuring geometries

- **"Connect Assist"** technology for quick exchange of measuring geometries and automatic rotor identification
- **Integrated solvent trap ring** used in combination with a sample cover to avoid drying out
- **Different types of coaxial cylinders** of various materials, in multiple sizes and with different surfaces
- **Double-gap cylinder geometry** for measuring low-viscosity fluids
- **Parallel plates** in different diameters and with different surfaces
- **Cone and plate geometries** in multiple diameters and with different cone angles
- **Lower plates** matching the upper geometry in diameter and surface appearance. For precise sample filling and ideal measuring conditions
- **Vane rotors** for relative measurements on highly filled or inhomogeneous samples with large particles as well as for measurements in original containers
- **Disposable geometries** for hardening materials
- **Cylinders and parallel plates** with serrated or sandblasted surface to avoid wall-slip effects
- **Solid clamps** for Dynamic Mechanical Thermal Analysis (DMTA)
- **SER** (Sentmanat Extensional Rheometer) tool for extensional properties
- **Universal adapters** for individual rotors, e.g., for ISO 2555 spindles
- **Customized measuring geometries** available on request

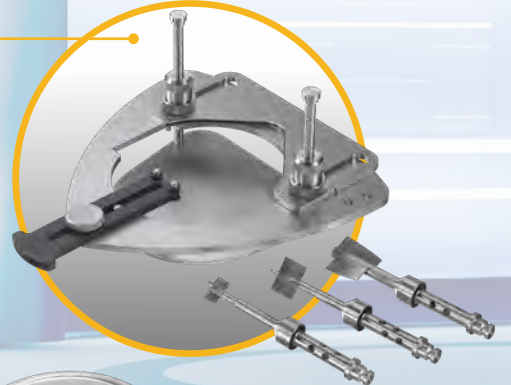
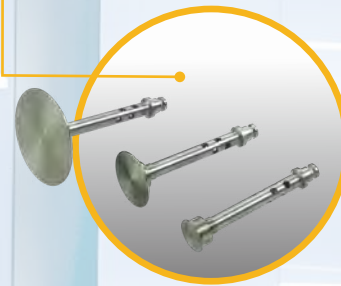
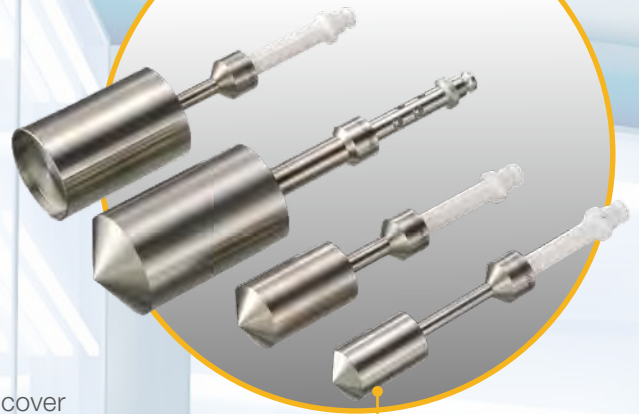

Confidently control sample temperature from -150 °C to 600 °C

- Plug-and-play temperature modules with quick coupling and automatic recognition
- Universal modules switch between coaxial cylinders and parallel plates or cone and plate geometries in seconds
- High-heat transfer materials guarantee fast temperature equilibrium and rapid temperature changes
- Rotors with ceramic shafts reduce heat conduction when using sample hood
- Automatic temperature calibration tool ensures correct sample temperature

Peltier temperature module – quickly change temperature within the mid temperature range, from -60 °C for parallel plate as well as cone and plate measuring geometries or from -40 °C for coaxial cylinders up to 200 °C.

Liquid temperature module – control temperature with high precision; this offers the most reasonably priced temperature control method when using an existing circulator.

Electric temperature module – measure within a broad temperature range; for parallel plates as well as cone and plate measuring geometries for temperatures up to 400 °C; for coaxial cylinders or application-based measuring cells such as high pressure cells for temperatures up to 300 °C.

Controlled Test Chamber (CTC) – Unique combination of convection and radiation heat transfer for very fast temperature changes and homogeneous temperature distribution from 30 °C to 600 °C; can be extended to -150 °C with the premium, low temperature option.

Universal active and passive upper temperature modules – Combine individually with the lower temperature module. Set-up is done in seconds with a mounting mechanism which is part of the measuring head, along with trim position for optimal sample filling, nitrogen connection for inert gas atmosphere and integrated solvent trap.

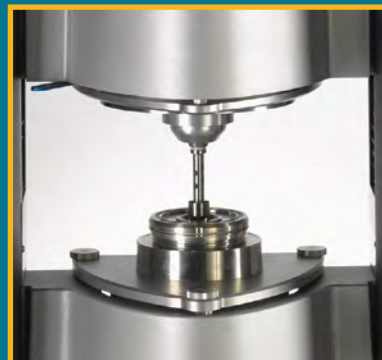

Universal Peltier temperature module



Temperature module for parallel plates with sample hood



Temperature module for parallel plates with Insulated sample hood



Electrical temperature module for parallel plates with active upper heater

MARS factor 05

Application-based solutions

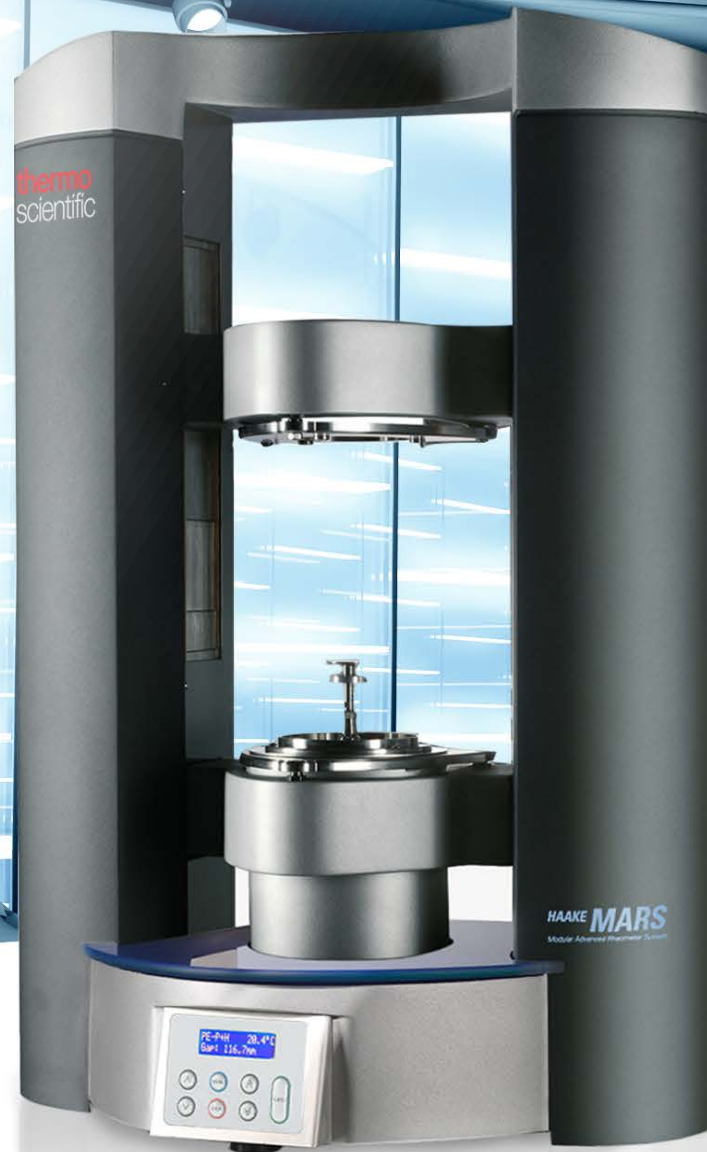

Upside-down version of the HAAKE MARS

Open platform for specific expansions

Thanks to its spacious and modular design, the HAAKE MARS rheometer can be easily and quickly adapted to new requirements. A variety of specialized and application-oriented measuring cells are available, e.g. for food, construction materials or UV-curing materials.

Custom measurement setups can be realized on request: The measuring head can be installed in the bottom holder if desired for optimal positioning in a beam path to enable the use of two measuring heads.

We are glad to consult you on further applications and can offer a broad accessory portfolio for these, too.



MARS factor 05

Application-based solutions

Cosmetics and pharmaceuticals

Creams, ointments, sprays, foams, gels – no matter what the product or application – rheological tests are essential for the development and optimization of cosmetic and pharmaceutical formulations. While simple viscosity measurements are often sufficient for evaluating raw materials, extensive rheological testing is necessary in order to predict and adjust product shelf life as well as processing and application behavior. The HAAKE MARS offers an extensive range of accessories for testing cosmetic and pharmaceutical materials.

Selection of accessories for pharmaceutical products and cosmetics:

- **High-performance Peltier** temperature control units for precise temperature control
- **Universal holder** for measurements in original product containers e.g., cream jars or cosmetic pots
- Thermo Scientific™ **RheoScope microscope** module for investigating structural changes of multi-phase systems and foams
- Du Noüy ring and Bi-Cone measuring geometry for performing **interfacial rheology**
- **Submersion flow cell** for testing semi-solid samples fully submerged in a liquid
- **21 CFR Part 11 module** for the HAAKE RheoWin software to meet FDA requirements



HAAKE MARS with Peltier temperature module and insulated sample hood TM-IN-H



Also available: Selection of falling ball and rotational viscometers/rheometers for fast and reliable viscosity measurement in routine Quality Control testing

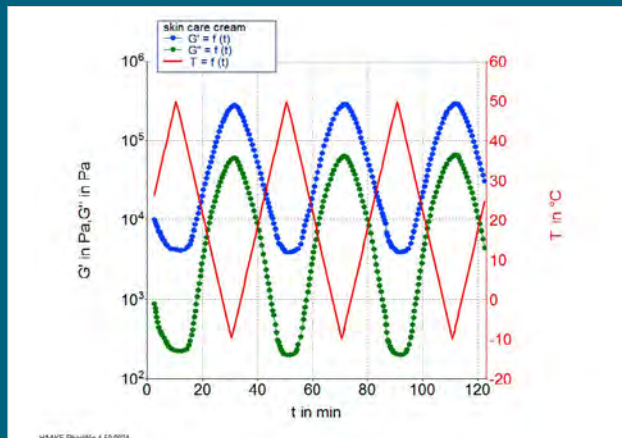

Rheological swing test to predict the temperature stability of cosmetic emulsions (Brunner et al.*). The test was performed with a 20 mm serrated parallel plate measuring geometry and a peltier temperature control module in combination with an insulated sample cover.

*R. Brummer; M. Griebenow; F. Hetzel; V. Schlesiger; R. Uhlmann: Rheological Swing Test to Predict the Temperature Stability of Cosmetic Emulsions; Verlag für chemische Industrie, H. Ziolkowsky GmbH, Augsburg, Germany; Proceedings XXI IFSCC International Congress 2000, Berlin; pp. 476

Food

Many important properties of food (e.g., flowability, pourability, and stability) are directly linked to measureable rheological parameters like viscosity, yield stress or viscoelasticity. Understanding rheological behavior helps food scientists to develop new formulations according to consumer preferences and manufacturing requirements.

From a simple viscosity curve of a liquid or semi-solid material to breaking tests of solid products, the HAAKE MARS provides the tools needed for a comprehensive investigation of raw materials as well as finished food products.

Selection of accessories for food:

- **Universal Peltier temperature** control unit to switch between coaxial cylinders, plates and cone in seconds
- **Universal container holder** for measurements in original sample containers (e.g., yoghurt cup or peanut butter jar)
- **Serrated or sandblasted measuring geometries** to eliminate wall slip of complex fluids
- **Texture analysis** of solid materials with sample fixture for bending and breaking test
- **RheoScope microscope module** for the investigation of crystallization and melting processes
- **Pressure cell** to simulate cooking processes
- Also available: **Thermo Scientific™ HAAKE CaBER 1 extensional rheometer** to investigate elongation flow (e.g., during chewing and swallowing)

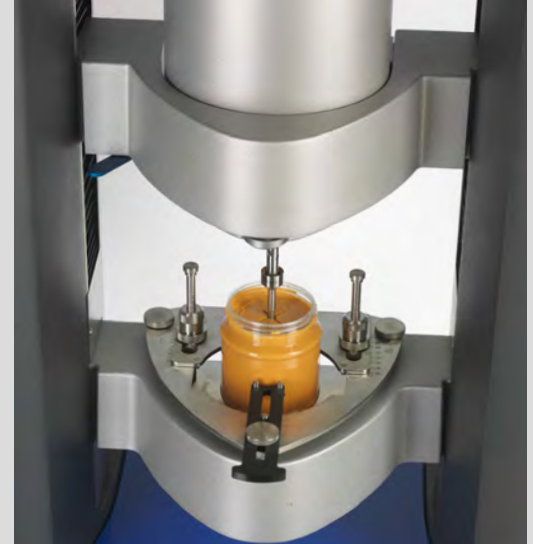

Peanut butter measured with HAAKE MARS, universal container holder and vane rotor

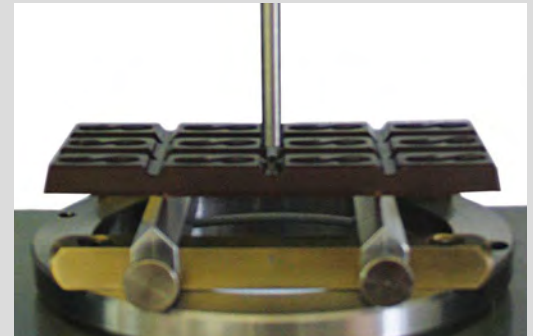

Texture analysis of a chocolate bar using a bending and breaking tool

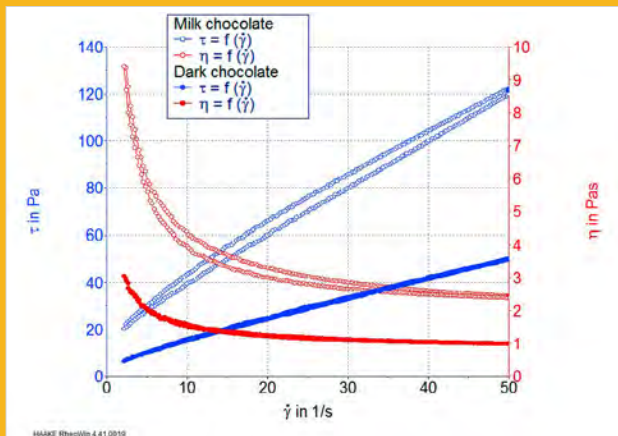

Rheological test of two different chocolate melts according to ICA method 46. The tests were performed with a CC25 DIN coaxial cylinder measuring geometry and a Peltier temperature control module.

MARS factor 05

Application-based solutions

Polymers

Our rheometer platform can be used to study the life cycle of a polymer – from its development in the R&D lab to the pilot plant and small scale production. Small sample volumes can be mixed with the Thermo Scientific™ HAAKE™ MiniLab compounder and for further rheological testing, test specimens can be produced with the Thermo Scientific™

HAAKE™ MiniJetPro injection molding system.

With the HAAKE MARS rheometers, the viscoelastic properties of polymer melts and solutions as well as of solid specimens can be tested in shear, oscillation and elongation mode as a function of stress or strain, frequency, time or temperature.

Selection of polymer-specific accessories:

- **Controlled temperature chamber (CTC)** for measurements in the range from -150 °C to 600 °C
- Self-centering and self-adjusting clamps for **Dynamic Mechanical Thermal Analysis (DMTA)** of solid specimens and measurements according to DIN/ISO 6721-1
- **Sentmanat Extensional Rheometer (SER)** tool from Xpansion Instruments for extensional rheological measurements of polymer films
- Additional HAAKE RheoWin **Software-modules for Polymer Analysis** (Time Temperature Superposition TTS, Spectra and Molecular Weight Distribution MWD)



Solid clamps for DMTA on a solid bar



SER tool for extentional measurements of a polymer film

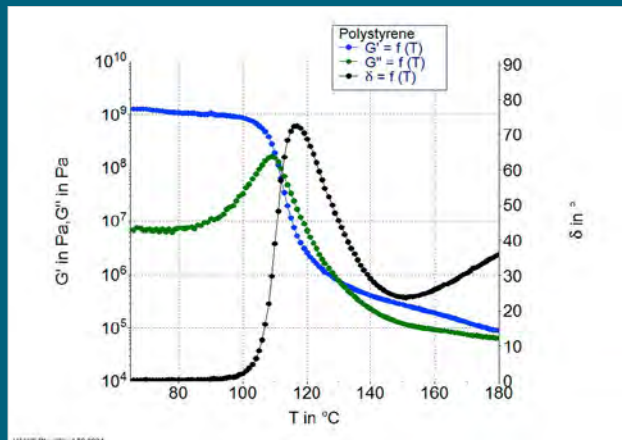

Dynamic Mechanical Thermal Analysis (DMTA) of a polystyrene. The test was performed with 8 mm parallel plates measuring geometry and the Controlled Temperature Test Chamber (CTC).

Petrochemicals

Over 30 billion barrels of crude oil are conveyed and processed annually. The viscosity of crude oils, with varying compositions at different temperatures and pressures, is used to optimize the flow behavior at various stages of production and transport. In addition, understanding the viscoelastic behavior of drilling

and boring fluids helps to improve formulations and increase oil field outputs.

From extraction to processing, HAAKE MARS rheometers with specialized accessories can analyze a range of rheological properties to optimize oil production.

Selection of specific accessories for the petrochemical industry:

- Comprehensive **pressure cell portfolio** for tests at pressures up to 600 bar and temperatures up to 300 °C. Titanium and Hastelloy® pressure cells available. Coaxial cylinder, double gap and vane rotors can be used
- **RheoScope microscope** module for studying the waxing behavior of crude oil
- **Tribology measuring cell** based on the ball on three plates principle for performance tests with greases and lubricants

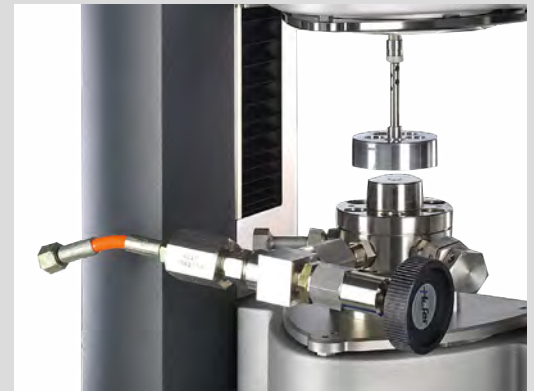

Configuration for high pressure tests



Tribology measuring cell

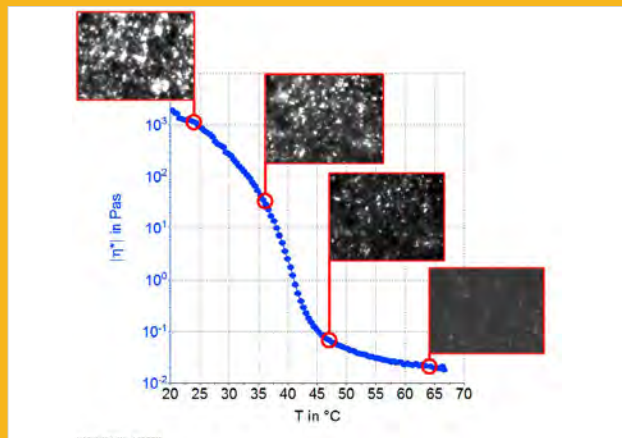

Rheo-optical investigation of the temperature-dependent crystallization of a crude oil. The test was performed with the RheoScope module in combination with the active upper-temperature control module and a 60 mm parallel plate measuring geometry.

MARS factor 05

Application-based solutions

Paints, inks and coatings

The regulatory requirements and environmental demands placed on paints, inks and coatings are constantly increasing as eco-friendly technologies and products play an important role in sustaining our planet. This includes using water as a diluting agent, solvent-free powder coatings and UV irradiation as a

fast, energy-saving cross-linking method. The flow behavior of these products is highly complex, but can be controlled when the relevant parameters are known. The HAAKE MARS platform supports these rheological demand in every phase of your multilayered process.

Selection of application-specific accessories for paints, inks and coatings:

- **Sample covers**, including solvent traps to prevent samples from drying out
- **Double gap geometries** to measure low-viscosity inks
- **Plate/ring measuring geometry** for the investigation of drying processes of solvent based systems
- **Disposable, parallel plate measuring geometries** eliminate time-consuming cleaning
- **High-shear measuring cell** for testing shear rates up to $200,000 \text{ s}^{-1}$ to simulate spaying and atomization processes
- Different **UV measuring cells** for standard and custom applications such as UV-assisted thermal curing
- Also available: **HAAKE CaBER 1 extensional rheometer**, for optimizing coating, filling and spraying processes

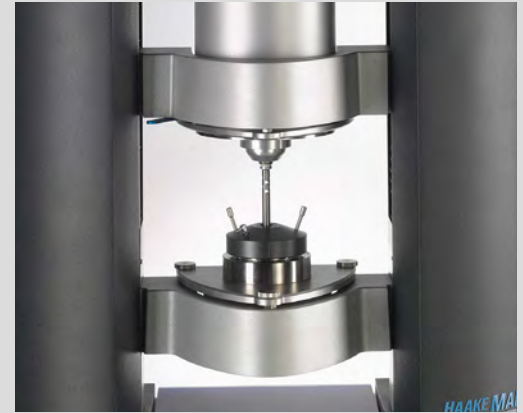

HAAKE MARS with Peltier Temperature Module, parallel plates and sample hood with solvent trap



UV curing cell

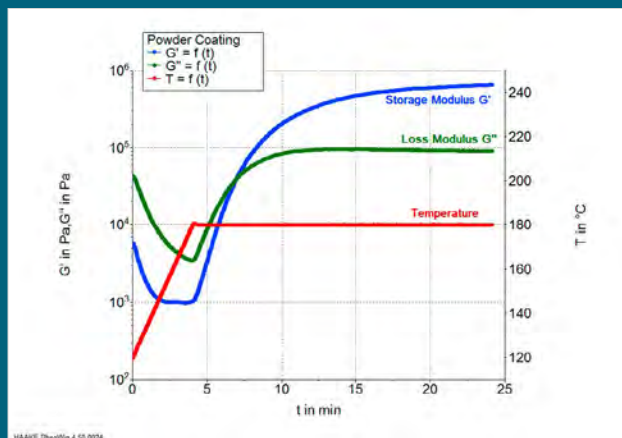

Investigation of the curing behavior of a powder coating. The test was performed with a 20 mm parallel plate measuring geometry and electrical upper and lower temperature control modules.

Construction and building materials

Construction materials like mortar, cement or ceramic slurries usually consist of larger solid particles suspended in water. If the particle size exceeds a certain limit, regular, small-gap measuring geometries cannot be used. However, using special vane rotor fixtures in combination with larger sample compartments permits rheological testing of these larger, particle-sized materials.

The HAAKE MARS rheometers can be equipped with a specialized, modular measuring cell designed for building materials. The unique and exchangeable lamella design at the outer wall of the large sample container prevents slippage effects caused by sample phase separation.

Selection of application-specific construction and building materials:

- **Measuring cell for building materials** with vane rotors and exchangeable lamella profiles for sample container. An optional temperature control unit and an external temperature sensor are available
- **Universal container holder** for measurements in the original sample container
- **Serrated and sandblasted measuring geometries** avoid sample slippage
- Also available: **HAAKE Viscotester iQ rheometer** with lab stand for tests in larger sample containers

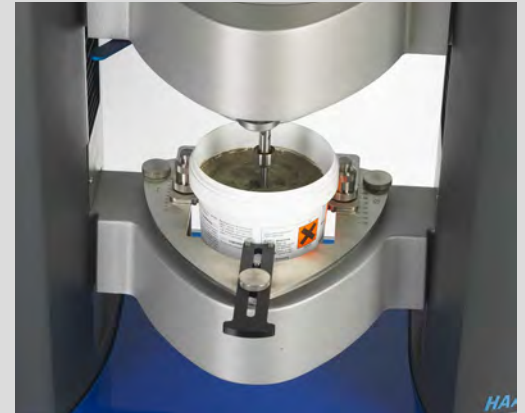

HAAKE MARS equipped with universal container holder for relative tests



Measuring cell for building materials

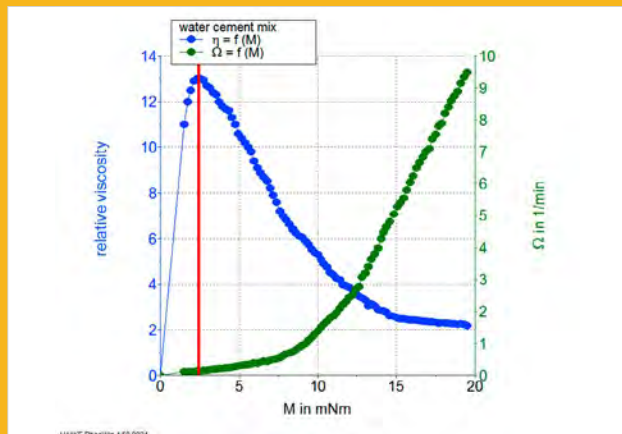

Determination of yield stress in Controlled Stress (CS) mode of a cementitious paste. For the measurement the HAAKE MARS was equipped with the measuring cell for building materials and a FL26 CMC vane type rotor.

MARS factor 05

Application-based solutions

Enhance material characterization with combined methods

Combined measuring methods

Rheometry is a “macroscopic” measuring method that provides information on the behavior of a sample under specified conditions. The mechanical properties of a material depend on its structure at the microscopic level. In order to determine the reasons for the rheological properties, rheological measurements must be combined with tests on the microscopic level, using FTIR* or microscopy, for example.

Benefits of combined methods:

- Same sample preparation
- Same measuring conditions
- Shorter test times
- Perfect correlation of results

RheoScope Module:

Rheology + optical microscopy

- Simultaneous rheological measurements and image acquisition
- Fully integrated, compact microscope unit for the HAAKE MARS
- Visualization of data and images in the same software package
- Analysis of structural changes under shear
- Image analysis software determines particle sizes, particle size distributions and structural analysis

Applications / samples

- Food: fat, starch
- Polymer: solution, melt
- Pharma / cosmetic: creams, lotions
- Paint / inks: printing paste, thickening agents
- Petrochemical: crude oil, drilling fluid



HAAKE MARS with RheoScope module

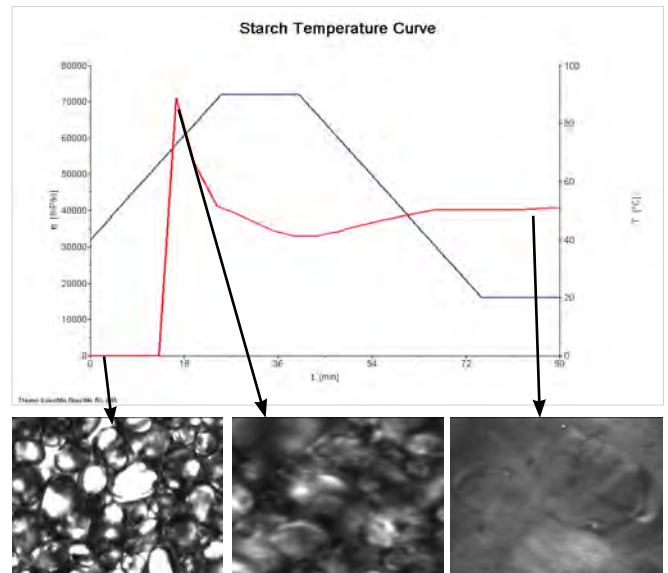

Temperature ramp study of potato wild type starch in water. For the measurement the HAAKE MARS was equipped with the RheoScope module including electrical temperature control and a 35 mm parallel plates geometry.

Rheonaut: Rheology + FTIR spectroscopy

- Simultaneous rheological and FTIR spectra measurements
- Unique technique in a compact module for the HAAKE MARS
- ATR (attenuated total reflection) principle
- Analysis of structural changes on the molecular level under shear / deformation
- Extensive investigation of thermal/UV curing reactions

Applications / samples

- Food: stability of emulsions
- Polymer: molecular orientation under shear
- Pharma: network formation of gelatine, denaturation of proteins
- Paint / Inks: chemical reactions, UV and thermal curing
- Others: curing reactions of adhesives, glues

Other combined methods on request

- For example, RheoRaman: Rheology + Raman spectroscopy

Acrylate glue curing monitored with the Rheonaut module on the HAAKE MARS and Nicolet iS10 FTIR spectrometer. The increase of the sample's moduli (red and blue) corresponds with the decreasing signal of the starting material (monomer in green) and the increasing signal of the final material (polymer's ester bond in black)



Modular rheometer platform HAAKE MARS with Rheonaut module and Thermo Scientific™ Nicolet™ iS™ 10 FT-IR spectrometer

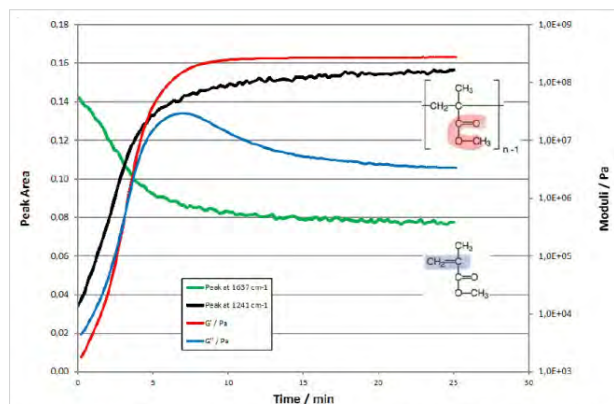

Specifications of the RheoScope module

Lenses	
Microscope	Focus and radial positioning by software-controlled servo motors
Lens ¹	5x, 10x, 20x and 50x
Light source ¹	150 W, 12 V, wave length range: 380 nm -750 nm
Resolution	1 μm (20x lenses)
Field depth	5 μm (20x lenses)
Contrast improvement	Polarizer adjustable by software-controlled servo motor
Camera	Black-and-white "progressive" scan CCD camera, with 1024 x 768 pixels, C connector and IEEE 1394 (Firewire) interface

Data acquisition and storage

Data acquisition	Up to 30 images per second ² in HAAKE RheoWin 4 Software
Storage	As image (3 standard image formats: TIFF, BMP, LWF) or Video sequences (configurable data compression)

Temperature range

Standard version	-5 °C ³ – 120 °C (liquid temperature control unit)
High temperature option	-5 °C – 300 °C (electrical temperature control unit)

Measuring geometries

Using a plate/plate and plate/cone measuring geometry with polished surface is recommended.

Specifications of the Rheonaut module

Spectrometer	Compatible with several standard IR spectrometers (side port required)
Measuring principle	<ul style="list-style-type: none"> • ATR using single reflection crystal (diamond) • DTGS (deuterated triglycine sulfate) detector • MCT (Mercury Cadmium Telluride) detector for fast spectra acquisition

Data acquisition and storage

HAAKE RheoWin software with integrated control of the FTIR spectrometer (for selected spectrometer models), automatic synchronization of rheological data and FTIR spectrum data

Temperature range

Standard version	0 °C – 120 °C (Peltier temperature control unit)
High temperature option	Ambient -400 °C (electrical temperature control unit)

Measuring geometries

Plates and cones with diameters up to 60 mm

¹ This component uses standard interfaces, individual components can be adapted

² Depending on the performance parameters of the computers used

³ Depending on thermostats

MARS Factor 05

Application-based solutions

Custom services

We are committed to exceptional customer support with short response times, customer-specific solutions and a comprehensive range of services. Our friendly customer service specialists will guide you through the variety of rheology resources that we have to offer.

Application laboratories and support

Our fully equipped laboratories reflect our application expertise and commitment to innovation. Our laboratories are in constant demand for testing customer samples and developing pioneering applications that help build your understanding of different materials. We also provide a broad range of rheology solutions to meet your application needs. Consult our application scientists to answer your specific questions and be more confident in the data you generate.

Trainings courses, seminars and webinars

We offer our customers a comprehensive training program and selected courses available through our international training center located in Karlsruhe, Germany. Basic and advanced rheology seminars with training on special applications are continuously held worldwide.

Request an on-site seminar, attend a live online webinar or watch a recorded webinar at your convenience. Contact your local distributor or Thermo Fisher sales representative for training schedule details

Custom services to meet individual requirements

We offer a wide range of professional services for a variety of industries to help our customers improve their productivity and reduce costs. Individual attention to our customer's needs for sample-specific applications and instrument maintenance are a standard service. Additional service packages, warranty extensions or premium service packages, which can be bundled together, allow our customers to plan and budget for maintenance and service support. All services are provided by skilled and certified service engineers.

Two strong partners in rheology: HAAKE MARS and HAAKE ViscoTester iQ. Benefit from the compatibility and transfer test methods from R&D to QC.



Comprehensive knowledgebase

We offer educational resources to enhance your knowledge on Rheology including applications that help streamline your daily workflow.

Selected product information and application notes:

- P031** Flexible holder for individual components
- P033** Spectroscopical insight into rheology with the Rheonaut module
- P040** HAAKE RheoScope module: image acquisition at very high shear rates using a stroboscope light source
- V262** Investigation of Pharmaceutical Hot Melts via Simultaneous Rheometry and Polarization Microscopy
- V263** Tracking Fast UV Curing Reactions in a Rheometer Using the Fast Oscillation Mode



HAAKE MARS specifications

Technical data	HAAKE MARS 40	HAAKE MARS 60
Min. torque rotation CS (nNm)	20	10
Min. torque rotation CR (nNm)	20	10
Min. torque oscillation CS (nNm)	10	2
Min. torque oscillation CD (nNm)	10	2
Max. torque (mNm)	200	200
Torque resolution (nNm)	0.1	0.1
Motor inertia (kgm ²)	10 ⁻⁵	10 ⁻⁵
Motor type	Drag cup	Drag cup
Bearing type	Air bearing: 2x radial, 1x axial	Air bearing: 2x radial, 1x axial
Angular resolution (nrad)	12	12
Min. rotational speed CS (rpm)	10 ⁻⁷	10 ⁻⁷
Min. rotational speed CR (rpm)	10 ⁻⁸	10 ⁻⁸
Max. rotational speed (rpm)	1500 (4500) ^a	4500
Step in velocity (ms)	10	10
Min. oscillation frequency (Hz)	10 ⁻⁶	10 ⁻⁶
Max. oscillation frequency (Hz)	100	100
Min. Normal force (N)	0.01	0.01
Max. Normal force (N)	50	50
Normal force resolution (N)	0.001	0.001
Max. lift travel (mm)	240	240
Gap resolution (µm)	0.5	0.5
Min. lift speed (µm/s)	0.02	0.02
Max. lift speed (mm/s)	20	20
Min. temperature (°C) ^b	-150	-150
Max. temperature (°C) ^b	600	600
Dimensions W x D x H (mm)	600x600x890	600x600x890
Weight (kg)	59	59

Features HAAKE MARS 40 / 60

CD-OSC ^c	Yes
OSC raw data / Lissajous	Yes
Multiwave	Yes
Gap control: Force / speed / displacement for squeeze and tack test / texture analysis	Yes / Yes / Yes
Camera for image capturing	Standard (USB, Firewire)
Titanium measuring geometries with low inertia	Standard
Replaceable lower plates of various diameters / surfaces / materials	Yes / Yes / Yes
Quick coupling for rotor / temperature module	Yes / Yes
Automatic recognition of rotor / temperature module	Yes / Yes

Temperature modules

Peltier controlled plate, liquid-cooled	-60 °C – 200 °C
Peltier controlled plate, air-cooled	-5 °C – 200 °C ^d
Electrically controlled hood	-40 °C – 400 °C ^e
Liquid controlled plate	-40 °C – 200 °C
Electrically controlled plate	-40 °C – 400 °C
Peltier controlled cylinder	-40 °C – 200 °C
Liquid controlled cylinder	-40 °C – 180 °C
Electrically controlled cylinder	-20 °C – 300 °C ^e
Controlled test chamber	-150 °C – 600 °C

^a Option for high shear rates

^b Depending on temperature modules

^c True deformation control

^d Depending on ambient temperature

^e When using suitable measuring geometries

thermo scientific

Find out more at thermofisher.com/MARS

For Research Use Only. Not for use in diagnostic procedures. © 2021 Thermo Fisher Scientific Inc. All rights reserved. Hastelloy is a trademark of Haynes International. All other trademarks are the property of Thermo Fisher Scientific and its subsidiaries unless otherwise specified.
BR010815_E 0121 M

ThermoFisher
S C I E N T I F I C